

PLAN VIEW

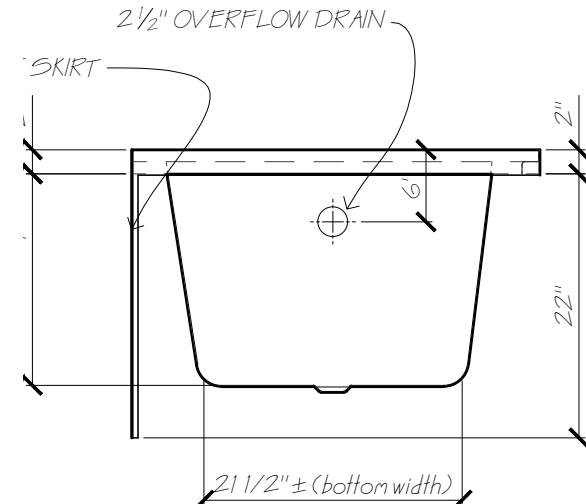

END VIEW

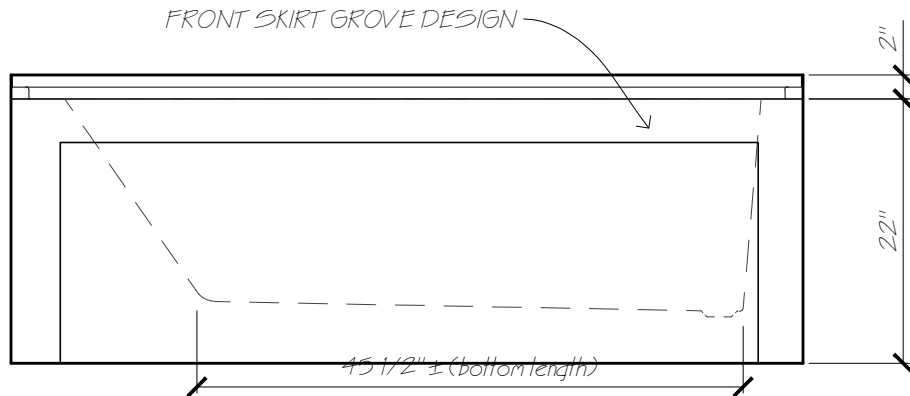

FRONT VIEW



Name: SAANICH6634RH

Date: 13-06-15

Scale: 3/4" = 1'

File: Saanich6634RH-3d.dwg Drawn: AAJimenez



Phone: 604-854-5757

Fax: 604-852-1850