

PLAN VIEW

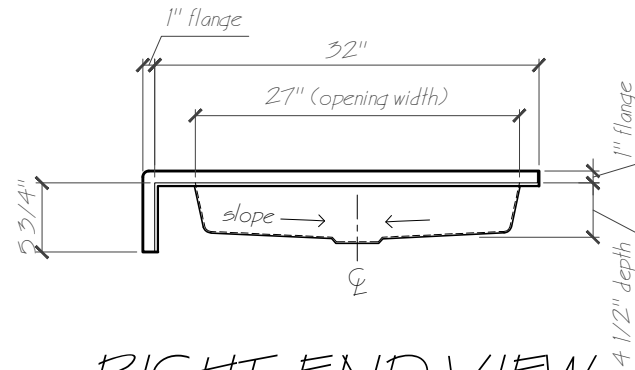

RIGHT END VIEW

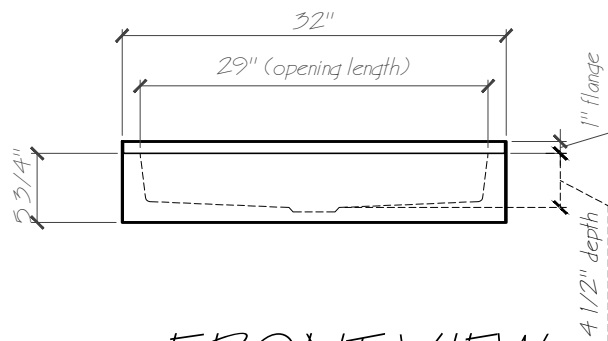

FRONT VIEW

Name: SB3232 (Shower Base 32" X 32")

Date: 10-08-12

Scale: 3/4" = 1"

File: SB3232-3d.dwg

Drawn: AA Jimenez



Phone: 604-854-5757

Fax: 604-852-1850