

PLAN VIEW

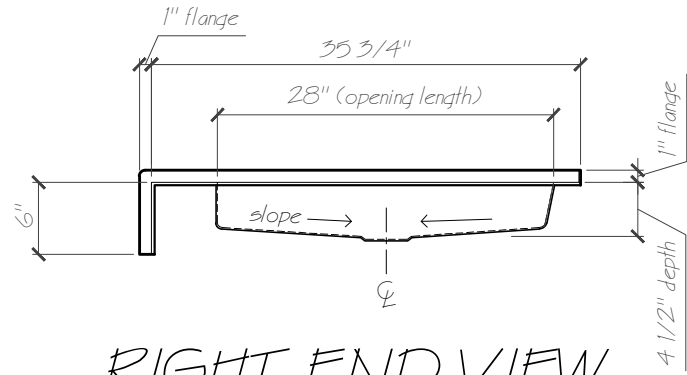

RIGHT END VIEW

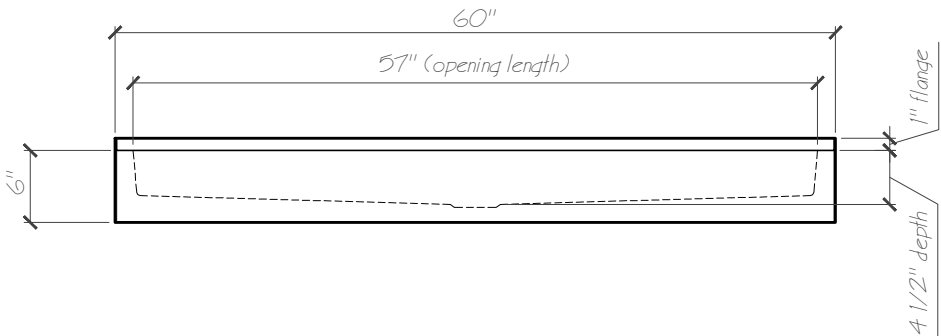

FRONT VIEW

Name: SB6036 (Shower Base 60" X 35-3/4")

Date: 13-08-12 Scale: 3/4" = 1"

File: SB6034-3d.dwg Drawn: AA Jimenez



Phone: 604-854-5757
Fax: 604-852-1850